

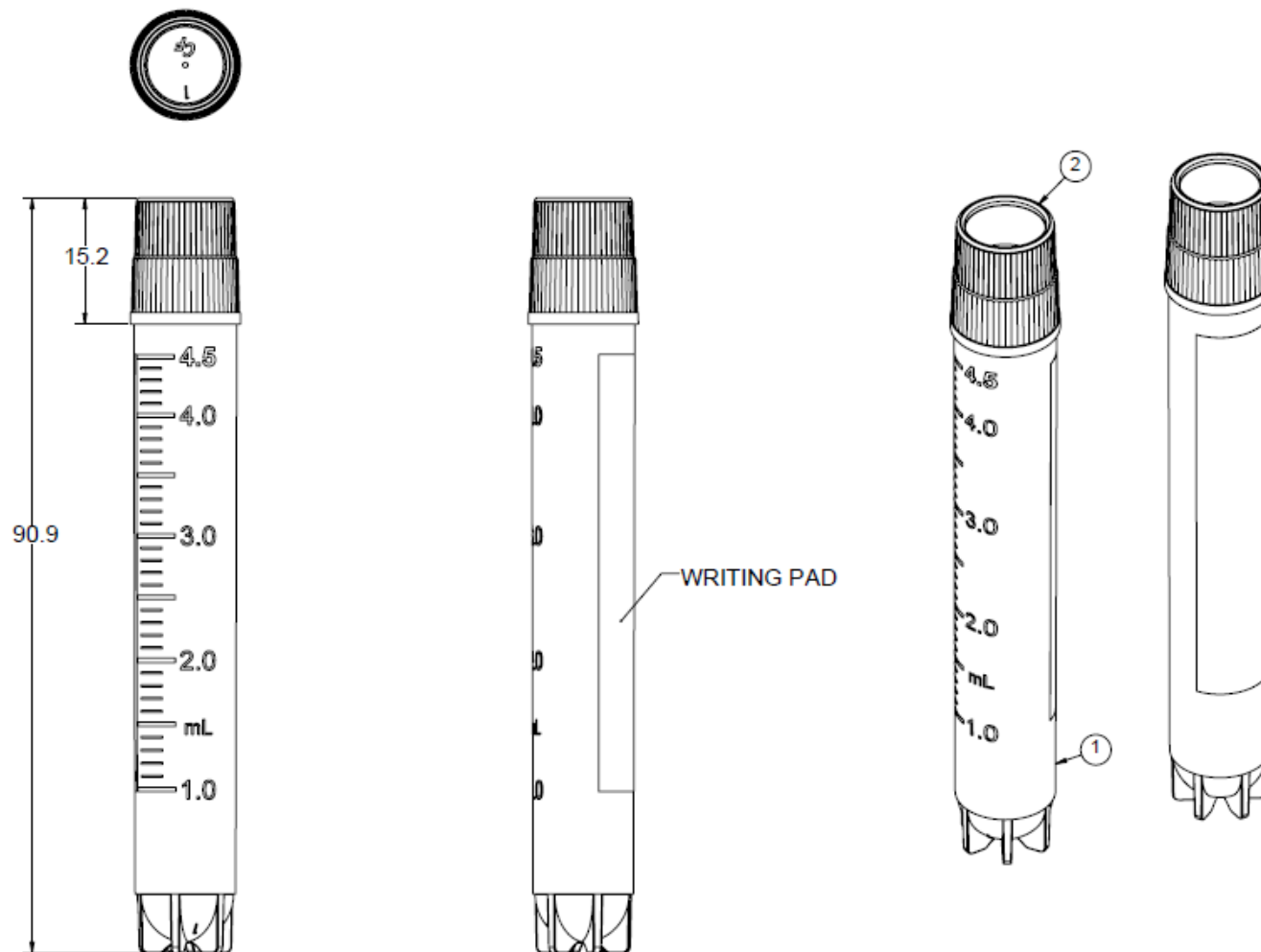

westburg
LIFE SCIENCES



WB 7745 4.5mL CRYO VIAL, EXTERNAL THREAD, STAR BASE

Arnhemseweg 87
3832 GK Leusden
The Netherlands

P.O. Box 214
3830 AE Leusden
The Netherlands

+31 33 495 0094
info@westburg.eu
www.westburg.eu

IBAN NL78RABO0168460297
NL005049532B01
KvK 31024246

